

99170

Dimensions

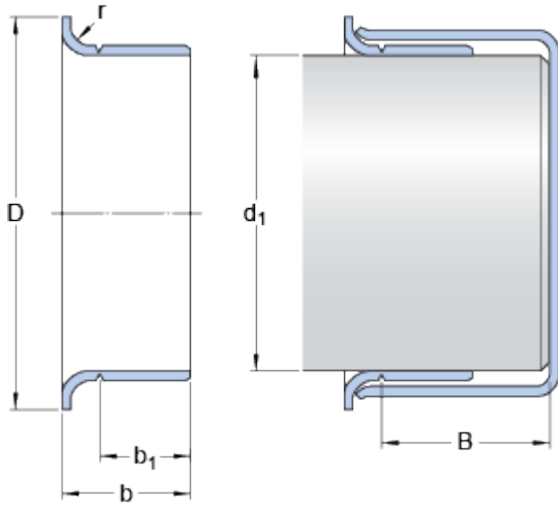

Nominal dimensions

d_1		44.171	mm
D		52.4	mm
Tolerance outside diameter D	\pm	1.6	mm
b		12.7	mm
Tolerance width b	\pm	0.8	mm
b_1		9.525	mm
Tolerance width b_1	\pm	0.8	mm
B	max.	20.65	mm
r	max.	3.18	mm

Shaft diameter range

d_1	min.	44.094	mm
d_1	max.	44.247	mm